



Ingenium**DOORS**  
Design to live



*Key to perfection*

# Valores

Calidad + Diseño + Seguridad + Innovación = Ingenium doors

# Visión

Nuestra empresa quiere ser un referente en el sector de las puertas de alta calidad y seguridad, como proveedora de productos vanguardistas y tecnológicos que aporten valor a los usuarios.

# Misión

Mediante el compromiso de los trabajadores queremos generar valor y satisfacción a los usuarios, proporcionando productos innovadores de alta calidad que combinan funcionalidad, estilo y respeto al medio ambiente.





## Values

*Quality + design + security + innovation = Ingenium Doors*

## Vision

*Our company wants to be a reference in the industry of high quality and security doors, as an avant-garde and technological products provider that bring value to users.*

## Mission

*With the commitment of our employees and a great experience acquired over the years, our mission is to create value and satisfaction to users, by offering them innovative high quality products, that combine functionality, style and respect of the environment.*

## Empresa

Somos fabricantes de puertas desde el año 1993 y gracias a nuestro saber hacer nos hemos convertido en un referente en términos de estilo y calidad. Por lo tanto, si usted compra uno de nuestros productos, está invirtiendo en un producto que cumple con los más altos criterios de durabilidad, funcionalidad y seguridad. Nuestra prioridad es la satisfacción del cliente y la búsqueda de la excelencia, para lo cual poseemos los certificados ISO 9001 y marcado CE.

Nuestros departamentos de calidad, administración, producción, logística y atención al cliente están alineados para proporcionar la mayor satisfacción y responder a las expectativas de nuestros clientes. Cada persona que forma parte de nuestra organización posee cualidades únicas y es el eslabón de un equipo orientado a lograr la excelencia.

Como estrategia empresarial en constante evolución, nuestra empresa colabora con empresas de I+D, institutos tecnológicos y diseñadores con el fin de proporcionar productos vanguardistas, prácticos y que mejoren la calidad de vida de las personas.

## Company

*We are door manufacturer since 1993, and thanks to our know-how, we have become a reference in terms of style and quality. Indeed, if you buy one of our doors or panels, you are investing in a product that complies with highest durability, functionality and security standards. Our priority is your satisfaction and pursuit of excellence. This is why we possess ISO 9001 and CE certifications.*

*Our quality, administration, production, logistic and customer service departments are aligned to provide you with satisfaction and best respond your expectations. Every single person from our company possesses unique qualities and is a tier of a chain dedicated to reach excellence.*

*As our company strategy is in constant evolution, we collaborate with R&D, technological institutes and designers in order to provide you with avant-garde and practical products that will improve quality of life of people.*



Los procesos de mejora continua, el compromiso, la experiencia, la participación e implicación de todos los miembros de la empresa forman parte de la cultura de nuestra empresa. Entre nuestras señas de identidad destacamos el cuidado diseño, la personalización del producto, sus materiales de alta calidad y su funcionalidad.

Como fabricantes europeos, nuestros productos son producidos al 100% en España y nuestra especialidad es la fabricación de puertas principales para los hogares. En nuestra empresa cuidamos hasta el más mínimo detalle, la materia prima, el diseño, el proceso productivo, el acabado y el servicio. En definitiva queremos aportar valor añadido a nuestros productos y a nuestros clientes.

Nuestra organización está comprometida en crear productos que mejoren la seguridad en el hogar, con el único propósito de cuidar a los que más quieres.

“ Cada uno de nuestros trabajadores guarda la llave de la puerta que conduce a la perfección”

*Continuous improvement, commitment, experience, participation and implication from every member of the company are part of our corporate culture. Meticulous design, product customization, high quality materials and functionality are part of our characteristics.*

*As a European manufacturer, our products are 100% produced in Spain and our specialty is front doors manufacturing. In our company, we pay careful attention to detail, from raw materials to customer service, design, production processes, service and finishing. Our first aim is to bring value to our products and our clients.*

*Our organization is committed to create products that will improve security in your home, with as unique objective to take care of what you like the most.*

*“Every worker in our company holds the key of the door that leads to perfection”*



## Sistema Productivo

### Porque elegir una puerta de aluminio?

El aluminio proporciona, además de un importante aislamiento térmico y acústico, alta seguridad y un mantenimiento sencillo. Gracias a la combinación de chapas de 1,5mm de aluminio anodizado, PVC extruido y poliestireno, nuestras puertas alcanzan una densidad 3000 kg/m<sup>3</sup>, garantizando un aislamiento optimizado.

Utilizamos accesorios fabricados en materiales como el acero inoxidable, aluminio nylon, latón, poliamidas ó polímeros con el propósito de garantizar la durabilidad y la calidad de nuestros productos.

Como características principales podemos destacar:

- Marco y hoja de aluminio
- Marco y hoja enrasados
- Triple junta
- Triple cristal laminado con doble cámara para un mejor aislamiento
- Rotura puente térmico
- Cilindro ISEO R7 antibumping (resistencia frente ataques, código de seguridad de la llave)
- Refuerzo de aluminio interior que protege la cerradura y es anti-arqueo
- Bisagras regulables
- Cerradero regulable
- Embellecedores de canales interiores
- Umbral anodizado en plata

## Production System

### Why choosing an aluminum door?

*Aluminum provides not only important thermic and acoustic isolation, but also high security and easy maintenance. Thanks to the combination of 1,5mm anodized aluminum sheets, extruded PVC and polystyrene, our doors reach a density of 3000 kg/m<sup>3</sup>, that guarantees an optimized isolation.*

*We use accessories made of stainless steel, nylon, brass, polyamides and polymers, in order to guarantee durability and quality of our products.*

*The main features of our products are the following:*

- *Frame and sash made of aluminum*
- *Trimmed profile and sash*
- *Triple gasket*
- *Triple laminated glass with double chamber for high isolation*
- *Thermal break door*
- *ISEO R7 anti-bumping cylinder (high attack resistance, security code of the key)*
- *Internal reinforcing aluminum bar that protects the lock and prevents the door from bowing*
- *Adjustable hinges*
- *Adjustable lock*
- *Makeup trims*
- *Brushed steel threshold*



Nuestros productos han sido testados para protegerlos contra agentes externos:

- Lluvia y agua
- Viento
- Oxidación
- Cambios de temperatura
- Rayos ultra violeta
- Impacto
- Ruido

Invertimos en el desarrollo de puertas sostenibles que puedan satisfacer el futuro mercado, en constante armonía con el medio ambiente. Durante el proceso de fabricación, invertimos en materiales ecológicos y libres de gases nocivos, con el objetivo de proteger el medio ambiente y reducir el impacto de nuestra actividad. Nuestras puertas os permitirán beneficiar del mejor aislamiento y reducir vuestro consumo eléctrico.

*Our products have been tested to protect you against external factors:*

- Rain and water*
- Wind*
- Oxydation*
- Temperature changes*
- Ultraviolet rays*
- Impact*
- Noise*

*We invest in development of sustainable doors that will satisfy the future market demand, in constant harmony with the environment. All along the production process, we invest in ecological and toxic gas free materials to protect the environment and reduce the impact of our activity. Our doors will also allow you to benefit from a better isolation and, consequently, reduce your power consumption.*



## Calidad

Nuestra empresa posee un banco de pruebas, en el cual se prueba cada una de las puertas que se fabrica para asegurar la calidad total. Buscamos una mejora continua del sistema de fabricación y materiales, mejora de la ingeniería de producto o de su funcionalidad del producto.

Con el fin de optimizar el proceso de fabricación y asegurar un perfecto acabado de nuestros productos, nuestra empresa utiliza la más avanzada tecnología entre la que cabe destacar:

- Máquina de corte doble cabezal
- Máquinas de control numérico (5 ejes)
- Prensa 8.000kg/M2 de carga
- Encoladora automática

## Quality

*Every single door goes through a quality control, where it is checked and tested in order to ensure the best quality. Our production system is constantly improving, and so are the product engineering and functionalities.*

*In order to optimize the production process and ensure a perfect finished product, our company uses the most advanced technologies which include:*

- Double headed cutting machine
- C & C machine
- Press with a charge of 8000 kg/m<sup>2</sup>
- Automatic gluing machine

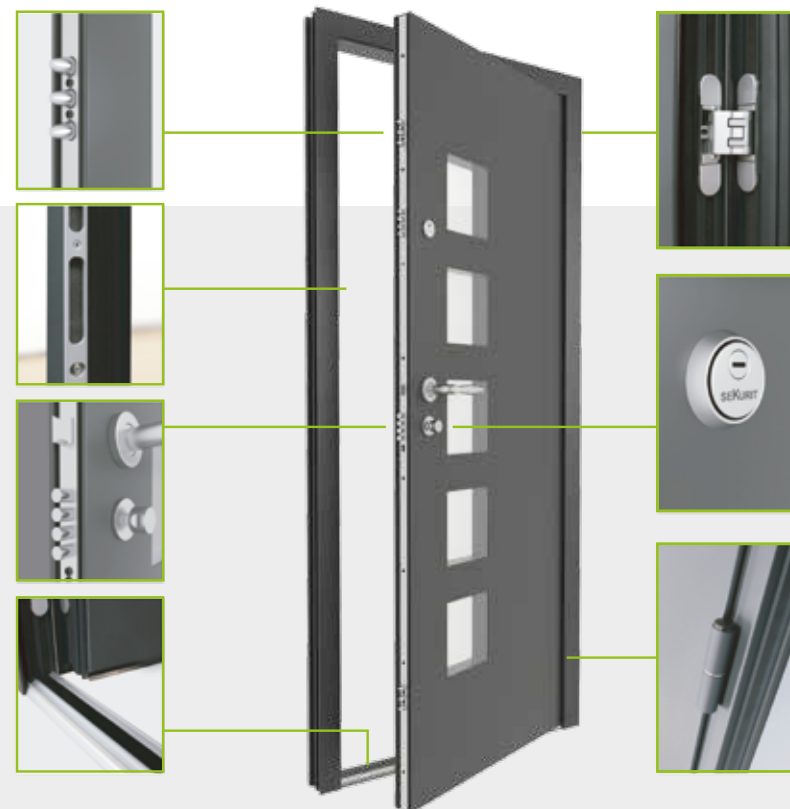





## Elige tu puerta ideal

Selecciona el sistema de tu puerta dentro de las 3 categorías de Ingenium Doors:

SeKurity 10 .....	p. 10
SeKurity 14 .....	p. 11
Sistema Estándar .....	p. 12

Selecciona el diseño de tu puerta dentro de las 4 colecciones de Ingenium Doors:

Moderna .....	p. 13
Elegance .....	p. 21
London look .....	p. 27
Rústica .....	p. 29

## Create the ideal door for you

Select your door system among the 3 Ingenium Doors categories:

<i>SeKurity 10 .....</i>	<i>p. 10</i>
<i>SeKurity 14 .....</i>	<i>p. 11</i>
<i>Standard System .....</i>	<i>p. 12</i>

Select your door design among the 4 Ingenium Doors collections:

<i>Modern .....</i>	<i>p. 13</i>
<i>Elegance .....</i>	<i>p. 21</i>
<i>London look .....</i>	<i>p. 27</i>
<i>Rustic .....</i>	<i>p. 29</i>

# SeKurity 10

El sistema Sekurity 10 proporciona flexibilidad sin renunciar a la seguridad y aislamiento:

- Seguridad ( 10 puntos de cerradura )
- Aislamiento ( Espesor de 70 mm )
- Estilo ( Monoblock )

*The SeKurity 10 system provides you with flexibility without renouncing to security and isolation:*

- Security
- Isolation
- Style

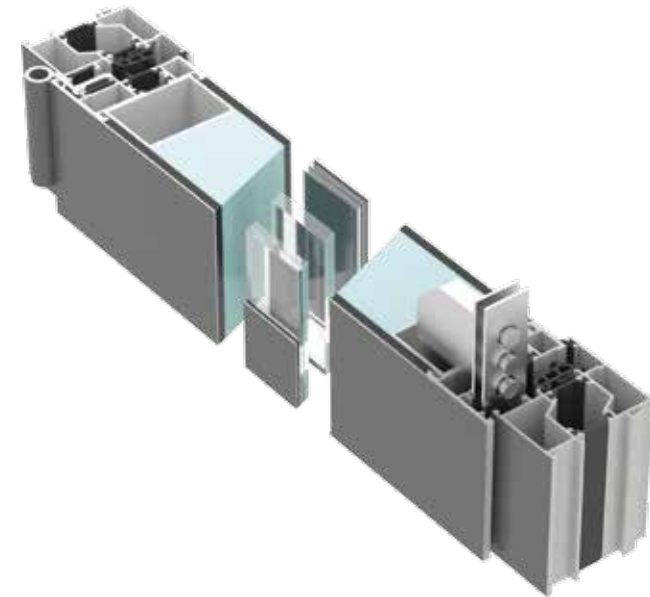

- 10 puntos de cerradura para más seguridad
- Puntos superiores e inferiores de forma cónica para mejor cerradura.
- Puerta mono-bloc de 70 mm de espesor: hoja de 70 mm y marco de 68 mm para mayor seguridad
- Sistema de hoja oculta
- Hoja compuesta de PVC extruido, polystyreno 56mm, panel aluminio 1,5mm ( aislamiento termico optimizado)
- Doble ruptura térmica (hoja y marco)
- Triple junta con junta central de EPDM con mayor capacidad de aislamiento
- Alta resistencia a los cambios de temperatura
- Bisagras convencionales y cerradero regulables
- Cilindro ISEO R7 de alta seguridad anti-bumping desplazado a 60mm del marco: apertura facilitada
- Cristal triple 3+3/24/4/24/3+3
- Umbral anodizado RPT 20mm

- 10 points locking for high security
- Upper and lower locking pins shaped conically for efficient closure
- One-block door: 70 mm thick sash and 67 mm thick profiles for high security
- Hidden sash system
- Aligned sash and profile
- Sash composed of extruded PVC, 56 mm polystyrene, 1,5 mm aluminum panel : high thermal isolation
- Double thermal break (sash and profile)
- Triple isolation, EPDM gasket for high isolation
- High resistance to climate changes
- Adjustable hinges and lock
- ISEO R7 cylinder, anti-bumping and placed 60 mm away from the frame: high security and easy opening
- Triple glass 3+3/24/4/24/3+3
- Anodized aluminum threshold

# SeKurity 14

Para aquellos que buscan la máxima seguridad, aislamiento y el mejor diseño, el sistema Sekurity 14 es la opción ideal.

- Seguridad ( 14 puntos de cerradura )
- Estilo ( Bisagra oculta )
- Aislamiento ( Espesor de 90 mm )
- Innovacion

*For those who are looking for maximal security, isolation and best design, the SeKurity 14 is the ideal option.*

- Security (14 locking points)
- Style (hidden hinges)
- Isolation (90mm thickness)
- Innovation

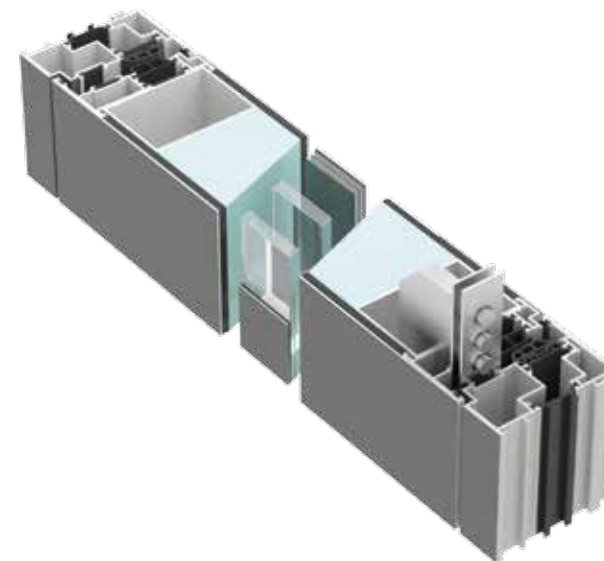

- 14 puntos de cerradura incluyendo una cerradura de servicio para alta seguridad
- Puerta mono-bloc de 90mm de espesor: hoja 90 mm y marco 88 mm para mayor seguridad
- Sistema de hoja oculta
- Marco y hoja coplanal
- Hoja compuesta de PVC extruido, poliestireno 76mm, panel aluminio 1,5mm: aislamiento térmico optimizado
- Doble ruptura térmica (hoja y marco)
- Alta resistencia a los cambios de temperatura
- Triple junta con junta central de EPDM con mayor capacidad de aislamiento
- Cerradero regulable
- Bisagras ocultas regulables 3D
- Cilindro ISEO R7 de alta seguridad anti-bumping con 5 llaves y bombillo desplazado a 60 mm del marco: apertura facilitada
- Cristal triple 3+3/34/6/34/3+3
- Umbral anodizado RPT 20mm
- Vierteaguas y cortavientos

- 14 locking points, including a service lock for high security
- One block door: 90 mm thick sash and 88 mm thick profiles
- Hidden sash
- Aligned sash and profile
- Sash composed of extruded PVC, 76 mm polystyrene, 1,5 mm aluminum panel : optimized thermal isolation.
- Double thermal break (sash and profile)
- High resistance to climate changes
- Triple isolation with EPDM gasket for high isolation
- Adjustable 3D hinges and lock
- ISEO R7 cylinder for anti-bumping security with 5 keys, placed 60 mm away from the frame: easy opening
- Triple glass: 3+3/34/6/34/3+3
- Anodized aluminum threshold 20mm
- Drip tray and wind break

## Sistema Estándar

La opción más apropiada para los que buscan el equilibrio entre modernidad, ligereza, funcionalidad y aislamiento.

- 5 puntos de cerradura
- Puerta mono-bloc de 70 mm de espesor
- Bombillo de alta seguridad
- Bisagras convencionales
- Umbral de 71 mm
- Aislamiento triple con junta central EPDM
- Cristal triple 3+3/24/4/24/3+3

Colores disponibles:



Ral. 7016 txt    Ral. 9016 mate

Medidas Estándares: consultar

Modelos disponibles: Helsinki y Oslo

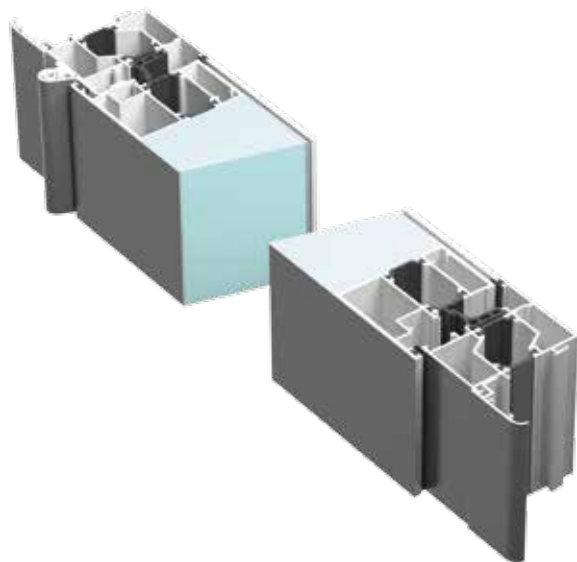

## Standard System

*The most suitable door for those who are looking for the perfect balance between modernity, functionality and isolation.*

- 5 locking points
- Hidden sash 70mm thick
- High security cylinder placed 60 mm away from the profile: easy opening
- Adjustable hinges
- 71 mm threshold
- Triple isolation with EPDM gasket
- Triple glass 3+3/24/4/24/3+3

Available colours :



Ral. 7016 txt    Ral. 9016 matt

*Standard dimensions: under request*

*Available designs: Helsinki and Oslo*



Mod. Helsinki

Mod. Oslo



Modern





Mod. Aguila



Mod. Altea



Mod. Andorra



Mod. Barcelona



Mod. Benidorm



Mod. Berlin



Mod. Bolonia



Mod. Bruselas



Mod. Calais



Mod. Canarias



Mod. Cannes



Mod. Champagne



Mod. Chicago



Mod. Colón



Mod. Creta



Mod. Dax





Mod. Florencia



Mod. Gibraltar



Mod. Ibiza



Mod. Le Mans



Mod. Lyon



Mod. Marte



Mod. Mallorca



Mod. Mercurio



Mod. Milan



Mod. Montreal



Mod. Moscou



Mod. Nantes



Mod. Oporto



Mod. Paris



Mod. Praga



Mod. Roma



Mod. Saint Malo



Mod. San Sebastian



Mod. Sagunto



Mod. Saturno



Mod. Senna



Mod. Sevilla



Mod. Siberia



Mod. Tokio





Mod. Valencia



Mod. Venus



Mod. Vienne



Mod. Alicante



Mod. Calpe



Mod. MV



Mod. MH4



Mod. Mh3



Elegance

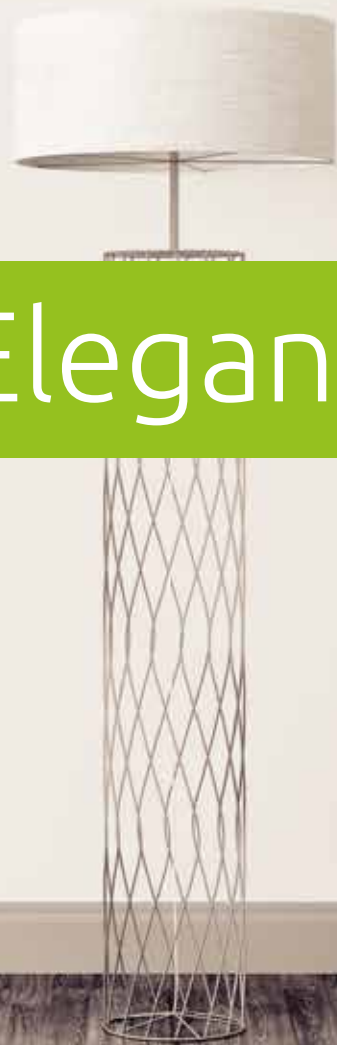

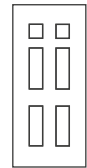

Atlanta1

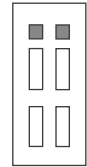

Atlanta2

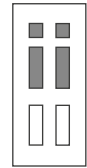

Atlanta3

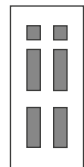

Atlanta4

Mod. Atlanta

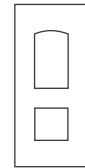

Boston1

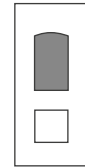

Boston2

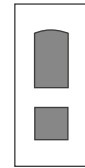

Boston3

Mod. Boston

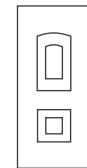

BostonBB1

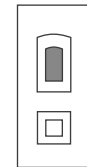

Boston BB2

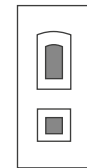

Boston BB3

Mod. Boston BB

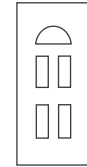

Cleveland 1

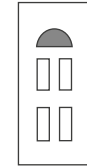

Cleveland 2

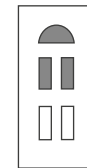

Cleveland 3

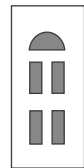

Cleveland 4

Mod. Cleveland

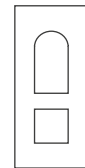

Denver1

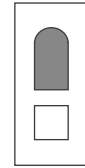

Denver2

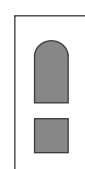

Denver3

Mod. Denver

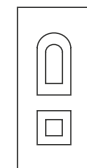

Denver DD1

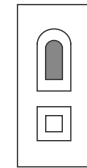

Denver DD2

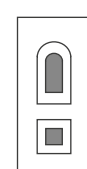

Denver DD3

Mod. Denver DD

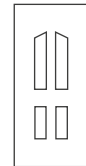

Ecuador 1

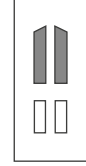

Ecuador 2

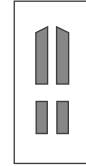

Ecuador 3

Mod. Ecuador

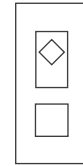

Georgia 1

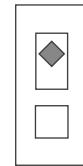

Georgia 2

Mod. Georgia

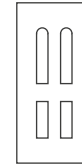

Houston 1

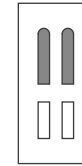

Houston 2

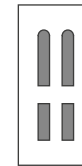

Houston 3

Mod. Houston

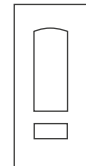

Illinois1

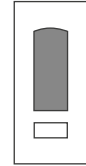

Illinois2



Illinois3

Mod. Illinois

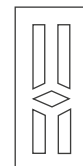

Kansas 1

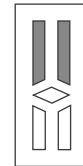

Kansas 2

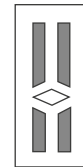

Kansas 3

Mod. Kansas

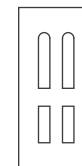

Lincoln 1

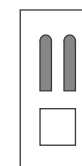

Lincoln 2

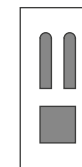

Lincoln 3

Mod. Lincoln







Madrid 1



Madrid 2

Mod. Madrid

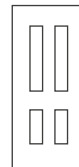

Miami 1

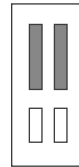

Miami 2

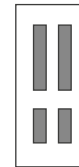

Miami 3

Mod. Miami

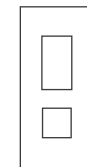

Oregon1

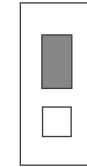

Oregon2

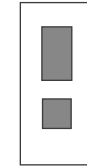

Oregon3

Mod. Oregon

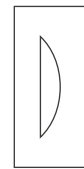

Picasso 1

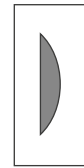

Picasso 2

Mod. Picasso

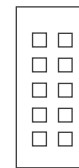

Provence1

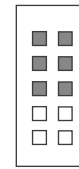

Provence2

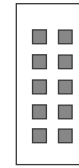

Provence3

Mod. Provence



Regina 1

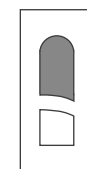

Regina 2

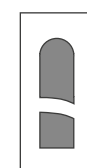

Regina 3

Mod. Regina

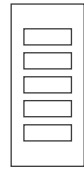

Sorolla 1



Sorolla 2

Mod. Sorolla

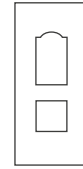

Tennesse 1

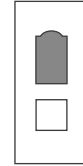

Tennesse 2

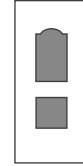

Tennesse 3

Mod. Tennessee

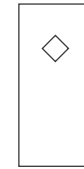

Venecia 1

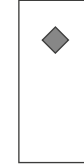

Venecia 2

Mod. Venecia



# London Look





Mod. Chelsea

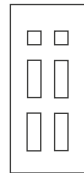

Chelsea 1

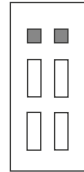

Chelsea 2

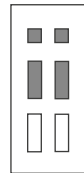

Chelsea 3

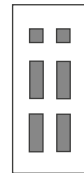

Chelsea 4



Mod. Chiswick

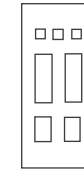

Chiswick 1

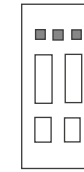

Chiswick 2



Chiswick 3

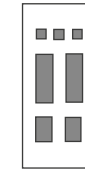

Chiswick 4



Mod. Knightbridge

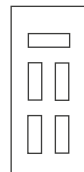

Knightbridge 1

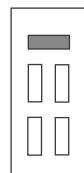

Knightbridge 2

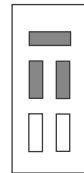

Knightbridge 3

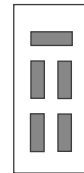

Knightbridge 4



Mod. Victorian

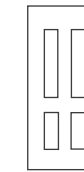

Victorian 1



Victorian 2



Victorian 3



Rustic





Cara exterior *Outer face*  
Cara interior *Inside face*



Cara exterior *Outer face*  
Cara interior *Inside face*



Cara exterior *Outer face*  
Cara interior *Inside face*



Cara exterior *Outer face*  
Cara interior *Inside face*



Cara exterior *Outer face*  
Cara interior *Inside face*



Mod. Ávila



Mod. Burgos



Mod. Castillo



Mod. Salamanca



Mod. Segovia

# Personaliza tu puerta *Customise your door*

## Colores RAL Básicos *Basic Colours RAL*



## Colores RAL Básicos Texturados *Textured Basic Colours RAL*



## Colores RAL Especiales *Special Colours RAL*

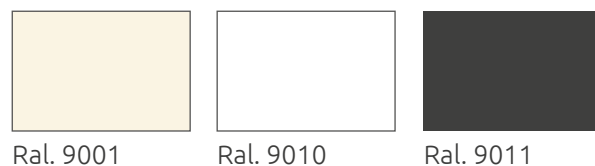

\* Los colores en este catalogo son una guía aproximada de los colores reales. Consultar la carta RAL  
*The colours in this brochure are an approximation of the real colours. Please consult the RAL chart*

## Madera *Wooden Effect*

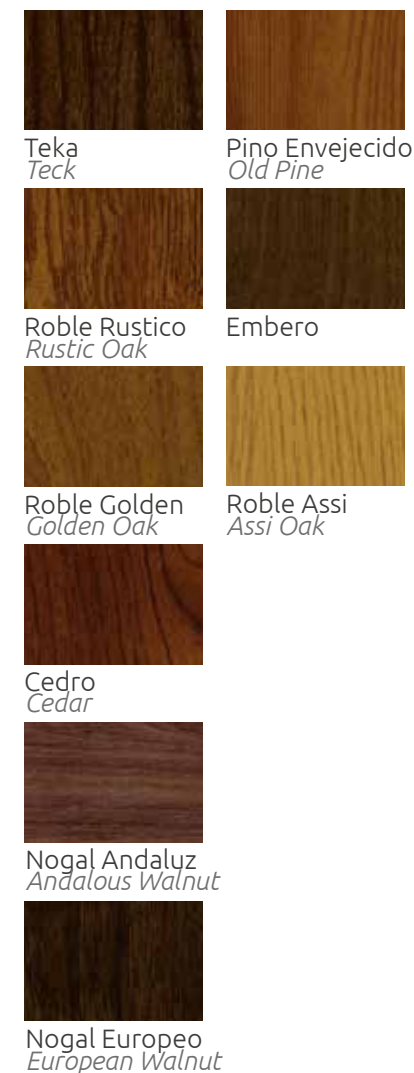



## Tu puerta a medida *Cut to size door*

	Medidas mínimas <i>Minimum dimensions</i>	Medidas máximas <i>Maximum dimensions</i>
SeKurity 10	1700 x 700 mm	2500 x 1100 mm
SeKurity 14	1700 x 700 mm	2300 x 1100 mm

## Opciones

Fijos laterales y superiores  
Doble hoja (disponible solo para SeKurity 70)  
Números (disponibles en acero inox)  
Cristales: Mate o transparente

## Options

Fixed side or head lights  
Double door (available for SeKurity 10 only)  
Numbers (available in stainless steel)  
Glasses : Matt or transparent

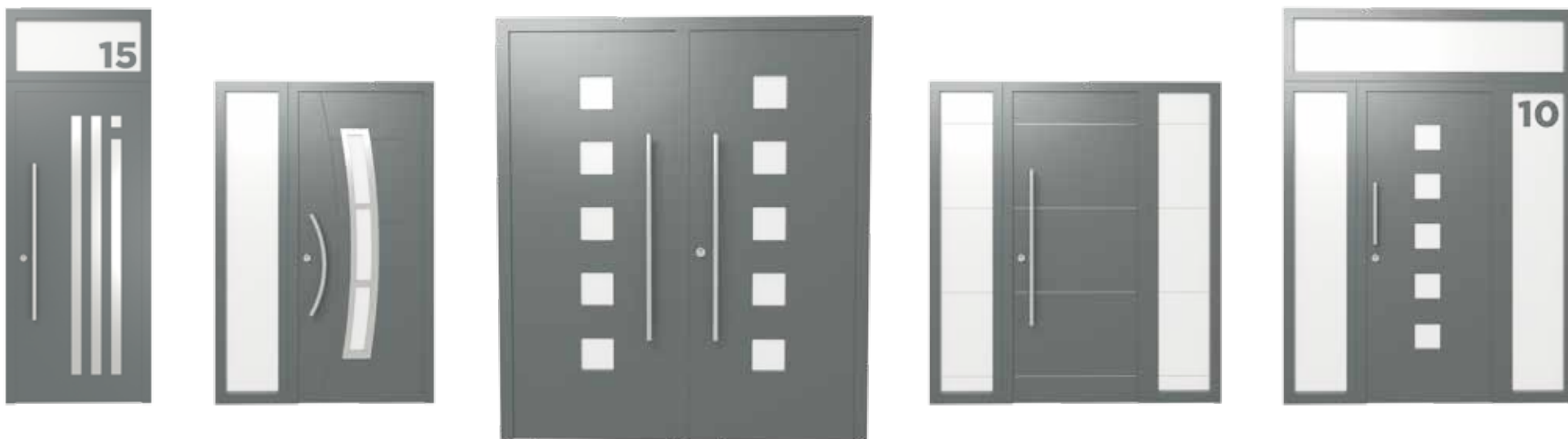

## Accesorios *Accessories*

### Accesorios para las colecciones **Modern y Elegant** *Accessories for Modern and Elegant collections*

Pomo *Door knob*

Acc\_500



Mirilla *Spyhole*

Mirilla electrónica *Electronic Spyhole*



Manillón *Door pull bar*

LONDON

Acc\_61041 - 400 mm  
Acc\_61042 - 600 mm  
Acc\_61043 - 1000 mm  
Acc\_61044 - 1400 mm  
Acc\_61045 - 1800 mm



PARIS

Acc\_7006-70 250 mm  
Acc\_7006-71 400 mm  
Acc\_7006-72 600 mm  
Acc\_7006-73 1000 mm  
Acc\_7006-74 1200 mm



---

---

SHANGHAI

Acc\_61051 400 mm  
Acc\_61052 600 mm  
Acc\_61053 1000 mm  
Acc\_61054 1800 mm



BERLIN

Acc\_61061 350 mm  
Acc\_61062 600 mm  
Acc\_61063 1000 mm



BANGKOK

Acc\_6112 800 mm



SYDNEY

Acc\_6101 600 mm



BUENOS AIRES

Acc\_81041 400mm  
Acc\_81042 600mm  
Acc\_81043 1000mm



RIO

Acc\_6113 550 mm



## Accesorios *Accessories*

---

### Accesorios para la colección **London Look** *Accessories for London Look collection*

---

Manivela *Handle*

Acc\_4400



Tirador *Door pull bar*

Acc\_710



Picaporte *Door knocker*

Acc\_8031



Acc\_8032



Acc\_810



Acc\_8521



Acc\_8522



Buzones *Letterboxes*

Acc\_301

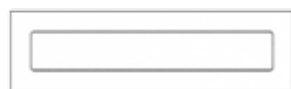

Acc\_302

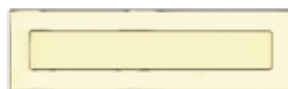

Accesorios para la colección **Rustic** *Accessories for Rustic collection*

---

Manivela *Handle*

Acc\_800 10

Acc\_800 01



Tirador *Door pull bar*

---

Acc\_800 02



Llamador *Door knocker*

---

Acc\_399



Bocallave *Keyhole*

---

Acc\_253





## Ensayos de Producto *Product Test*

Características <i>Characteristics</i>	Método de ensayo <i>Test method</i>	Unidades <i>Units</i>	Valor <i>Value</i>	
			SeKurity 10	SeKurity 14
Valor U <i>UD Value</i>	UNE EN ISO 12631:2015	W/m <sup>2</sup> K	0,7 ; 0,9	0,7 ; 0,9
Permeabilidad al aire <i>Air permeability</i>	UNE-EN 1026:2000	Clasificación <i>Classification</i>	2	2
Estanqueidad al agua <i>Water resistance</i>	UNE-EN 1027:2000	Clasificación <i>Classification</i>	3A	4A
Resistencia a la carga de viento <i>Wind charge resistance</i>	UNE-EN ISO 12211:2000	Clasificación <i>Classification</i>	C1	C2
Aislamiento acustico <i>Acoustic isolation</i>	UNE-EN ISO 10140-2:2011	dB	26 (-2;-2)	29 (-2;-2)
Resistencia al impacto <i>Impact resistance</i>	UNE-EN 14351-1:2006 + A1:2011	Clasificación <i>Classification</i>	C5	C5
Qualicoat	UNE		yes	yes
Eficiencia energetica <i>Energy efficiency</i>	UNE	Clasificación <i>Classification</i>	B+++	B+++

# Instalación en obra nueva o reposición *New Construction or Refurbishment Installation*

Elección de la instalación *Choose your installation :*

Obra nueva *New construction*

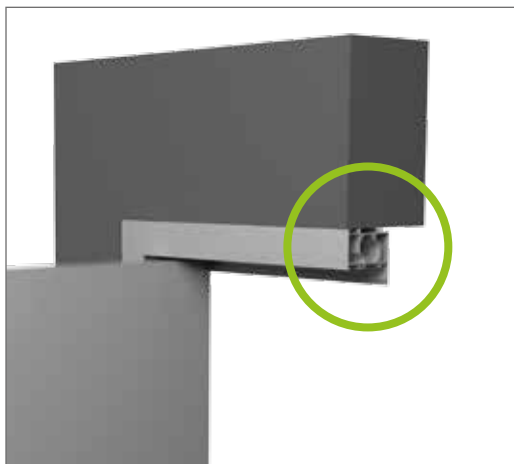

Renovación *Refurbishment or renovation*

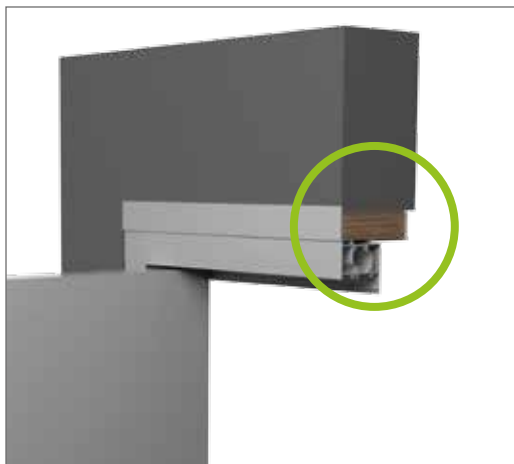

Coger las medidas de altura y de ancho  
*Take height and width measures:*

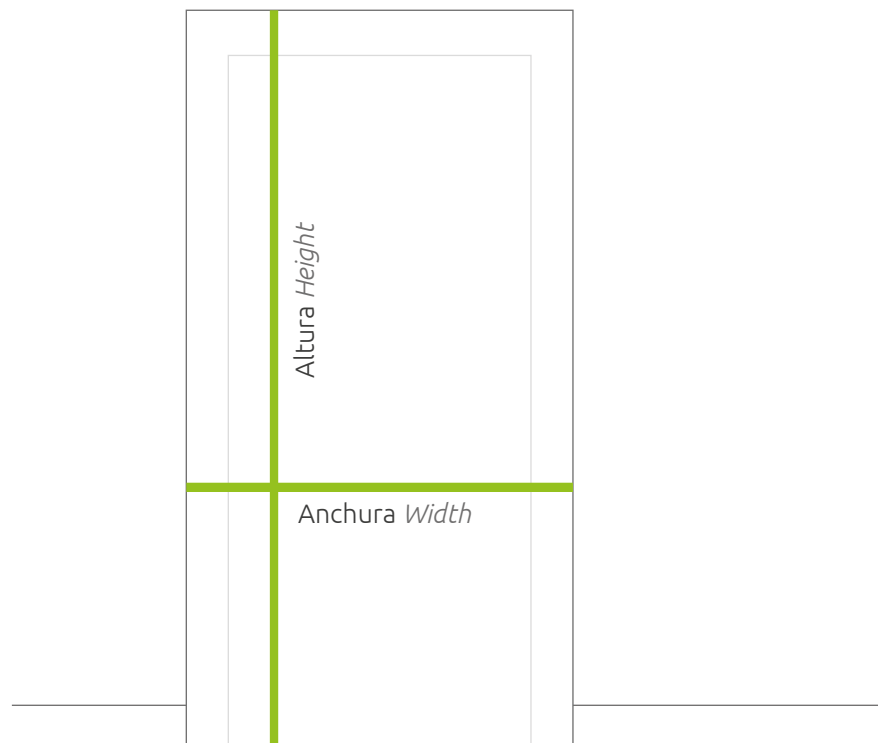



## Certificaciones *Certifications*

---

ISO 9001 desde hace 10 años *ISO 9001 since 2007*



Marcado CE *CE marking*



## Como hacer un pedido? *How to place an order?*



Modelo Siberia, en RAL 9011 matte, sistema Sekurity 14, en 2150x900mm, con solape, y con manillon de 1800mm



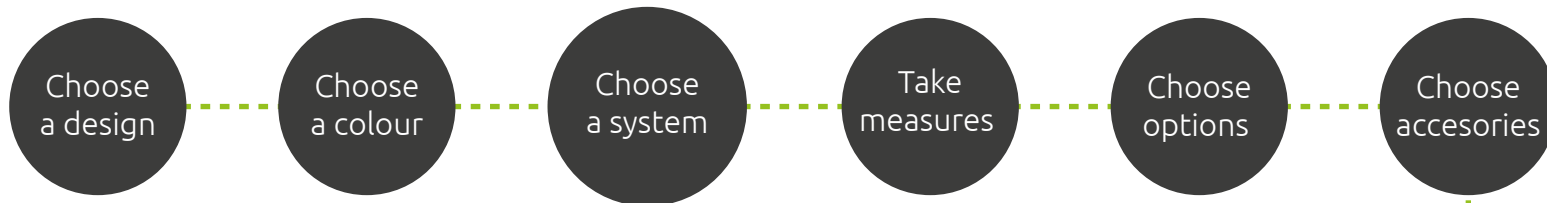

*Madrid Model, RAL 7011, SeKurity 10 system, measures 2000mm x850mm, with handle 710*





**IngeniumDOORS**  
Design to live

## PortalVent

Calle de la Virgen, 97.N1  
13300 Valdepeñas - Ciudad Real  
926 312 821  
620 366 914  
633 671172

[comercial@portalvent.com](mailto:comercial@portalvent.com)  
[www.portalvent.com](http://www.portalvent.com)

